



CS 77

Optimised safety and comfort



TOGETHER FOR BETTER

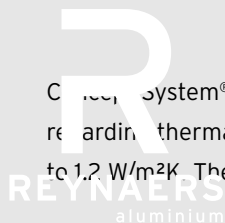
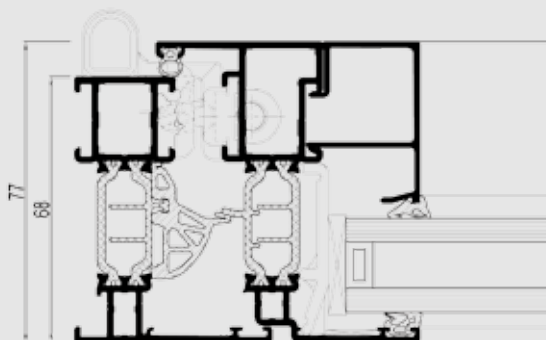
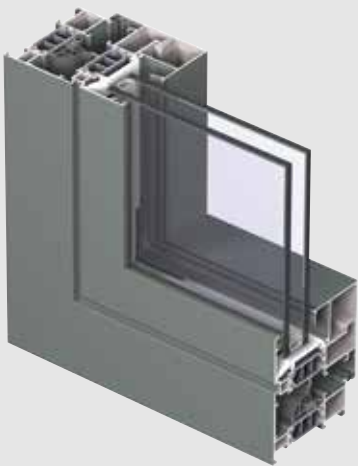

CS 77 system[®] 77 is a high insulation window and door system that meets elevated requirements regarding thermal insulation, stability and security. The system's HI+ variant achieves U_f values down to $1.2 \text{ W/m}^2\text{K}$. The U_f value of a frame/vent section with 115 mm visible width is $1.7 \text{ W/m}^2\text{K}$.

CS 77 is available in a variety of aesthetic styles to match the current trends whilst offering all types of both inward and outward opening windows and doors. An additional asset is the possibility to combine this system with Ventalis[®].









The system's performance regarding acoustics, water- and air tightness, but also for specific applications like Bullet - and Fire Resistance, meets the most severe European standards. Moreover, CS 77 is available in different burglar resistance levels (RC2 & RC3) making it an extremely secure system.



TECHNICAL CHARACTERISTICS

				
Style variants		FUNCTIONAL	RENAISSANCE	HIDDEN VENT
Min. visible width inward opening window	Frame	51 mm	51 mm	76 mm
	Vent	33 mm	33 mm	not visible
Min. visible width outward opening window	Frame	17.5 mm	-	-
	Vent	76 mm	-	-
Min. visible width inward opening flush door	Frame	68 mm	-	-
	Vent	76 mm	-	-
Min. visible width outward opening flush door	Frame	42 mm	-	-
	Vent	102 mm	-	-
Min. visible width T-profile		76 mm	76 mm	126 mm
Overall system depth window	Frame	68 mm	77 mm	68 mm
	Vent	77 mm	86 mm	72.5 mm
Rebate height		25 mm	25 mm	18.5 mm
Glass thickness		up to 53 mm	up to 53 mm	up to 48 mm
Glazing method		dry glazing with EPDM or neutral silicones		
Thermal insulation		32 mm omega and/or hollow chamber -shaped fibreglass reinforced polyamide strips		
High Insulation variant (HI)		Available	Available	Not Available
High Insulation Plus variant (HI+)		Available	Not Available	Not Available

PERFORMANCES

ENERGY											
	Thermal insulation ⁽¹⁾ EN ISO 10077-2	Uf-value down to 1.2 W/m ² K depending on the frame/vent combination and the glass thickness.									
COMFORT											
	Acoustic performance ⁽²⁾ EN ISO 140-3; EN ISO 717-1	Rw (C; Ctr) = 36 (-1; -4) dB / 42 (-2; -4) dB, depending on glazing type									
	Air tightness, max. test pressure ⁽³⁾ EN 1026; EN 12207	1 (150 Pa)		2 (300 Pa)		3 (600 Pa)		4 (600 Pa)			
	Water tightness ⁽⁴⁾ EN 1027; EN 12208	1A (0 Pa)	2A (50 Pa)	3A (100 Pa)	4A (150 Pa)	5A (200 Pa)	6A (250 Pa)	7A (300 Pa)	8A (450 Pa)	9A (600 Pa)	E900 (900 Pa)
	Wind load resistance, max. test pressure ⁽⁵⁾ EN 12211; EN 12210	1 (400 Pa)		2 (800 Pa)		3 (1200 Pa)		4 (1600 Pa)		5 (2000 Pa)	Exxx (> 2000 Pa)
	Wind load resistance to frame deflection ⁽⁵⁾ EN 12211; EN 12210	A (≤1/150)			B (≤1/200)			C (≤1/300)			
SAFETY											
	Burglar resistance ⁽⁶⁾ EN 1627-1630	RC 1			RC 2			RC 3			
	Fire resistance ⁽⁷⁾ - EN 13501-2, EN 1364-1, EN 1634-1 - NEN 6069	EI 30 EI 60, EI 45 EW 30									
	Bullet resistance ⁽⁸⁾ EN 1522	FB 1	FB 2	FB 3	FB 4	FB 5	FB 6				
				FSG		Kalashnikov					

This table shows possible classes and values of performances. The values indicated in red are the ones relevant to this system.

- The Uf-value measures the heat flow. The lower the Uf-value, the better the thermal insulation of the frame.
- The sound reduction index (Rw) measures the capacity of the sound reduction performance of the frame.
- The air tightness test measures the volume of air that would pass through a closed window at a certain air pressure.
- The water tightness testing involves applying a uniform water spray at increasing air pressure until water penetrates the window.
- The wind load resistance is a measure of the profile's structural strength and is tested by applying increasing levels of air pressure to simulate the wind force. There are up to five levels of wind resistance (1 to 5) and three deflection classes (A,B,C). The higher the number, the better the performance.
- The burglar resistance is tested by statistical and dynamic loads, as well as by simulated attempts to break in using specified tools.
- The performance is defined by directly exposing the construction to fire in order to determine the stability, thermal insulation and radiation insulation over a certain amount of time.
- The bullet resistance of the window or door is evaluated for different classes of weapons and ammunition: hand guns, (automatic) rifles and shot guns.